

- L
- L DCR
- H
- H (I)
- R HS H F
- L EMI

- R 
- DC/DC
- T -
- G
- L PC
- SSD

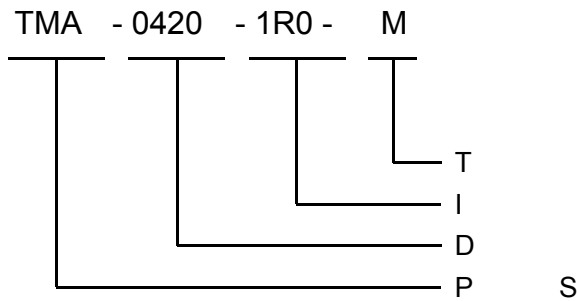

M= 20%
1R0=1.0 H

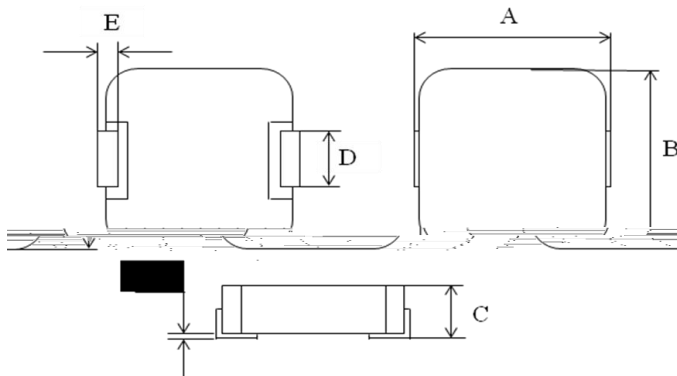

A	
B	
C	
D	
E	
F	

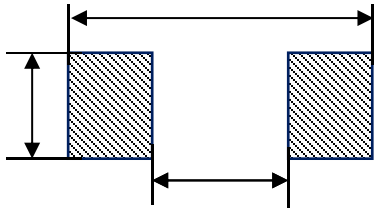

- T 3-
- F : 1R0 1.0 H, R10 0.1 H.

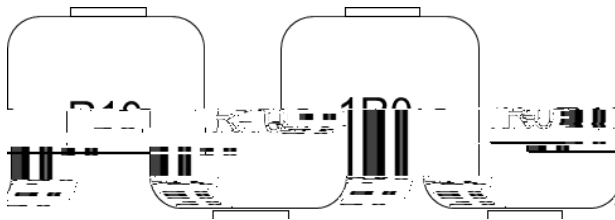

	$L_0(\mu\text{H})$	T	T .	M .	S	
					C	
					I (A .)	
					T .	T .
TMA -0420-R10-M	0.1	20%	3.1	4.0	25	12
TMA -0420-R22-M	0.22	20%	5.8	6.6	16	11
TMA -0420-R47-M	0.47	20%	12.5	14	9.5	7.5
TMA -0420-1R0-M	1.0	20%	20	26	7.0	5.0
TMA -0420-1R5-M	1.5	20%	38	46	6.0	5.0
TMA -0420-2R2-M	2.2	20%	45	58	5.0	4.5
TMA -0420-3R3-M	3.3	20%	76	87	4.0	3.2
TMA -0420-4R7-M	4.7	20%	92	105	3.0	3.0
TMA -0420-6R8-M	6.8	20%	125	150	2.8	2.5

1. A 23 3 C 45%RH 70%RH
2. T I : 3260B LCR M , 3265B B C S (100 H , 1), EUCOL-U25
DC L
3. O - 55 C + 125 C (+ -)
4. I : DC (A) L_0 30 %
5. I : DC (A) T 40 C
6. T (+) 125 C
. C , , P B
. P
7. T

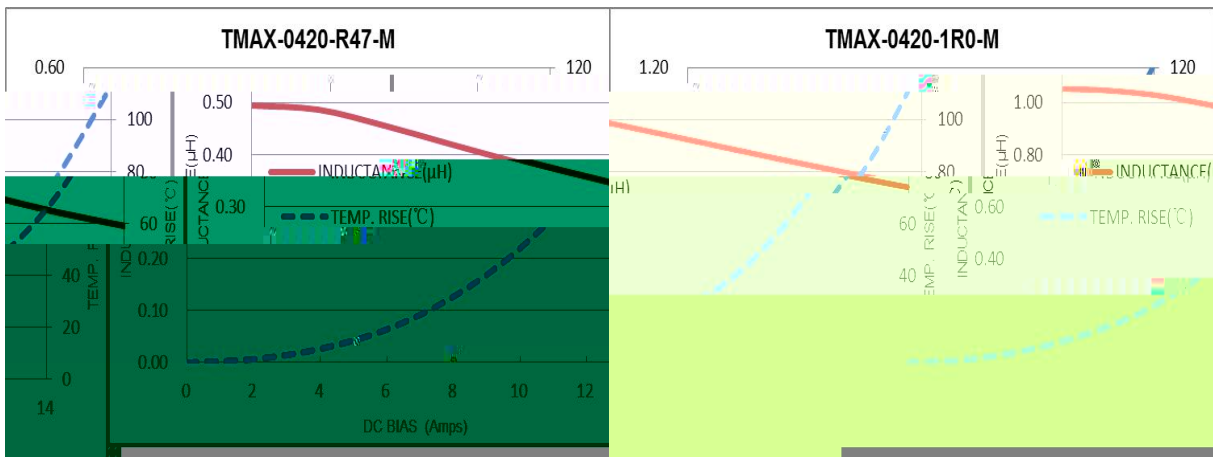
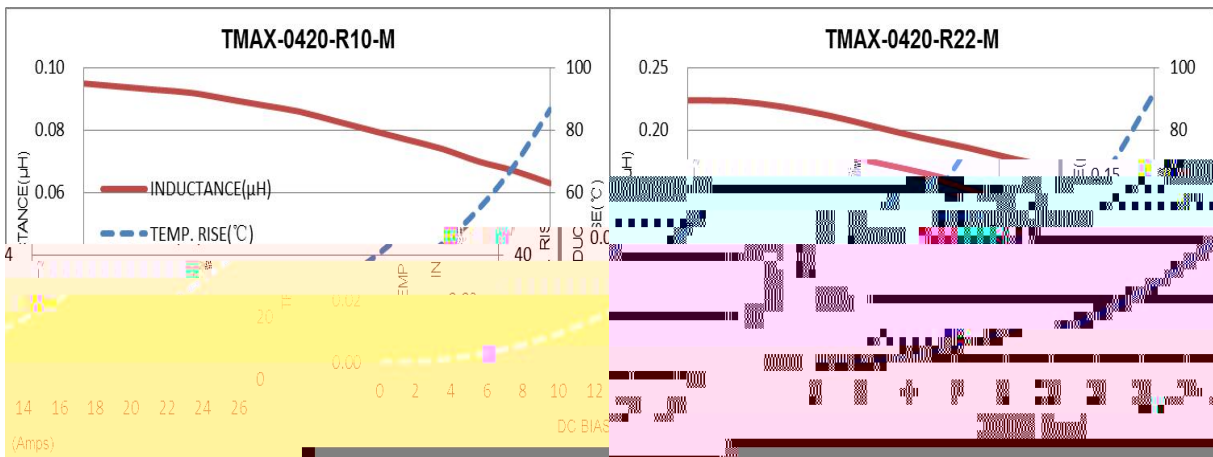

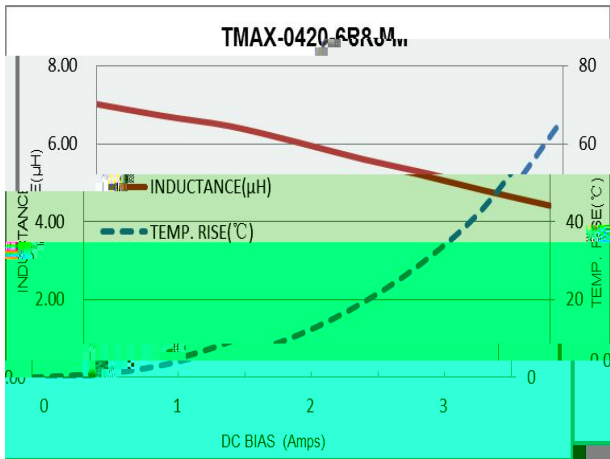
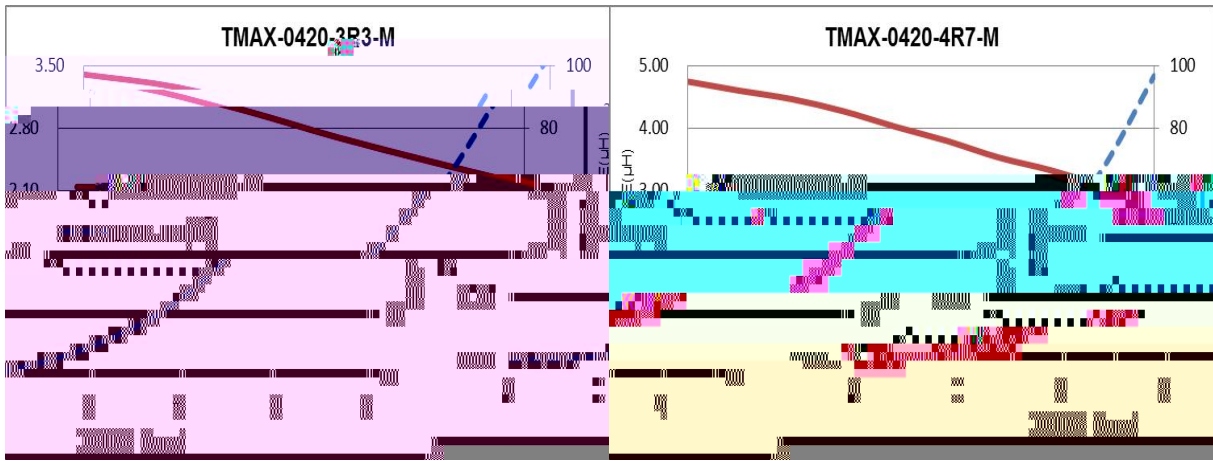
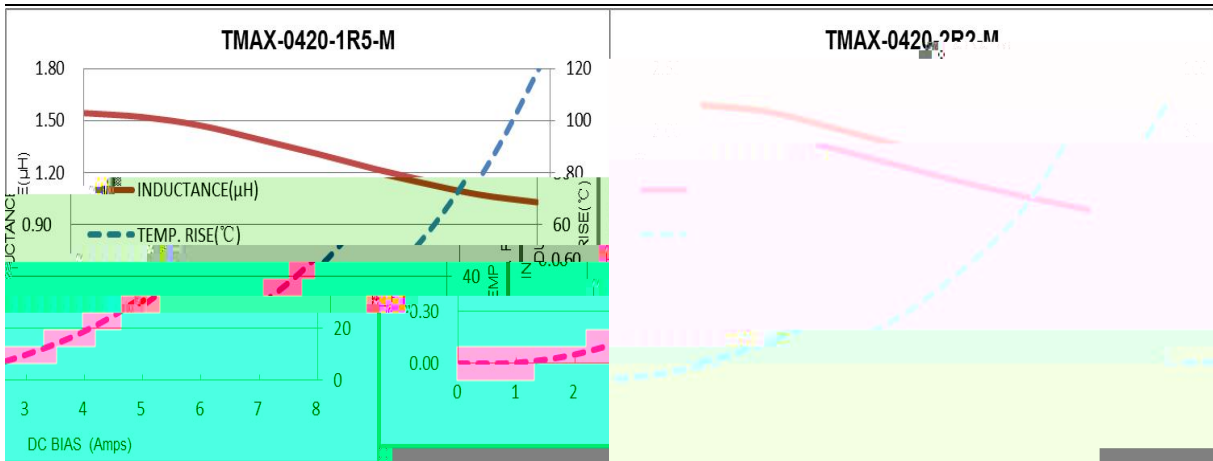

S	<p>S :</p> <p>1.P : 160 ± 10 C 90</p> <p>2.R : 245 ± 5 °C 2 ±</p> <p>0.5</p>	T 95%
	<p>1. (10H 55H 1 60</p> <p>2. : 3</p> <p>3.A : 1.5</p>	L/L ₀ ± 5% N
S	<p>1.P : 100 G</p> <p>2.D : 11</p> <p>3.3 3</p>	

T S	<p>1.R 100 : $(-55 \pm 2 \text{ C}, 30 \pm 3)$ → (R , 5) → $(+125 \pm 2 \text{ C}, 30$ $\pm 3)$ → (R , 5) 2.R : $48 + 4 / - 0$</p>	
H T R	<p>1.E T : $85 \pm 2 \text{ C}$ 2.A C : R 3.D : $1,000 + 4 / - 0$</p>	L/L ₀ ± 5%
H R	<p>1.E T : $60 \pm 2 \text{ C}$ 2.R H : 90 95% 3.A C : R 4.D : $1,000 + 4 / - 0$</p>	N
L T S	<p>1.S : $-55 \pm 2 \text{ C}$ $1,000 + 4 / - 0$</p>	
H T S	<p>1.S : $+125 \pm 2 \text{ C}$ $1,000 + 4 / - 0$</p>	

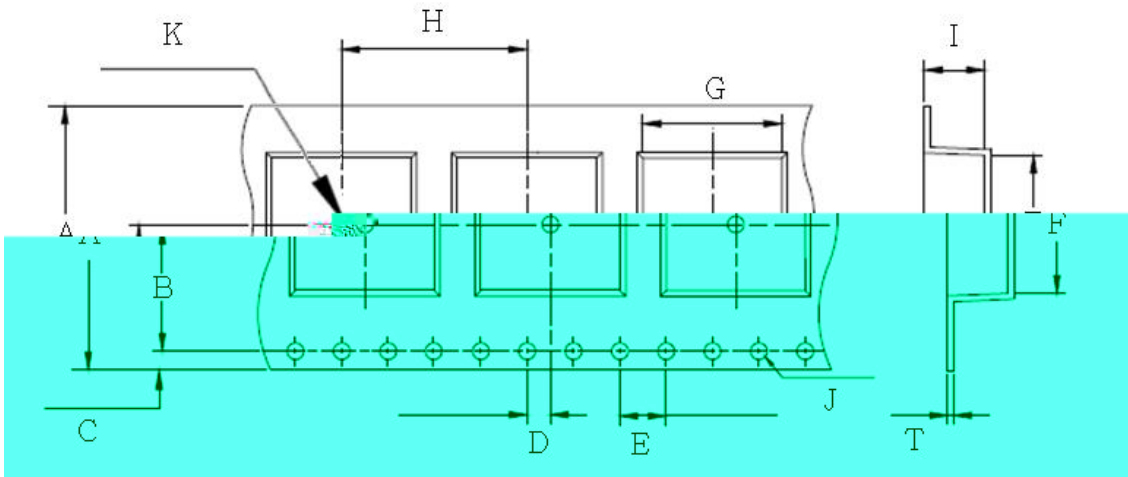

G	F	I	T	H	A
4.5 ± 0.1	4.8 ± 0.1	2.5 ± 0.15	0.35 ± 0.05	8.0 ± 0.1	12 ± 0.2
J	K	D	E	B	C
1.5 ± 0.1	1.5 ± 0.1	2.0 ± 0.1	4.0 ± 0.1	5.5 ± 0.1	1.75 ± 0.1

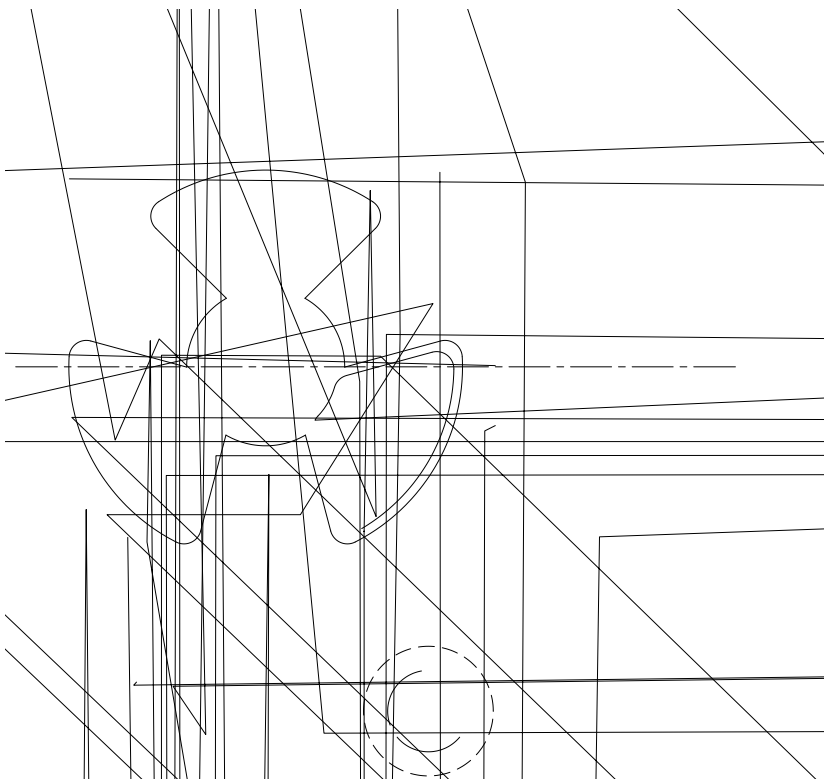

A	B	C
12.5 ± 0.2	2.0 ± 0.2	B

- T 300 / .
- T 0.1 0.7 N.

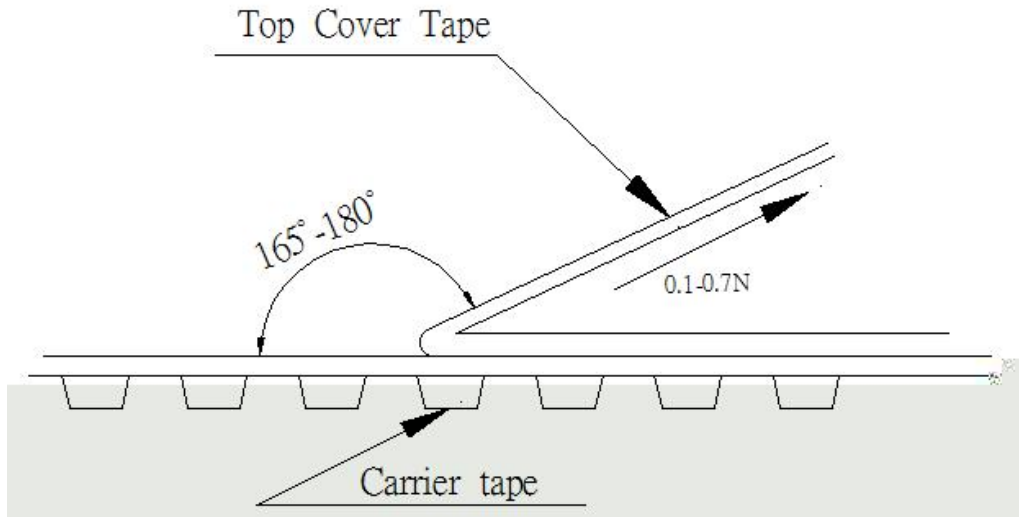

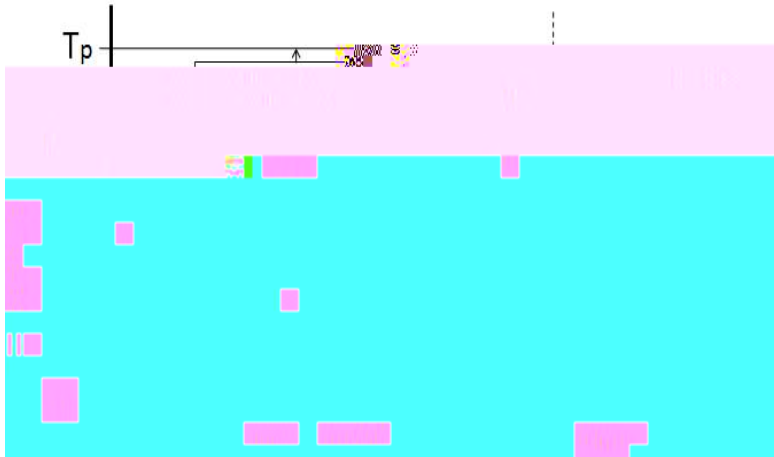

	<	≧
<2.5	235°C	220°C
≧2.5	220°C	220°C

	<		
<1.6	260°C	260°C	260°C
1.6-2.5	260°C	250°C	245°C
>2.5	250°C	245°C	245°C

P	S	T (T)	100°C
		T (T)	150°C
		T ():T T	60-120 S
A	TL T	3°C/S M .	3°C/S M .
L	(TL)	183°C	183°C
T	(L)	60-150 S	60-150 S
P	(T)*	T 1	T 2
T	()** 5 °C (T)	20 **	30 **
A	- T TL	6°C/S M .	6°C/S M .
T	25°C P T	6 M M .	8 M M .

*T (T)

** T ()

● 3,000 /

➤ P A C
T

, - - , .T ,
, ,

/ , , .

➤ T R
T

.I

➤ D S
D

➤
T

➤ P
I

.P

➤ D
P

➤ N
T

(, ,) ..TDG H C .,L .

.I ,