

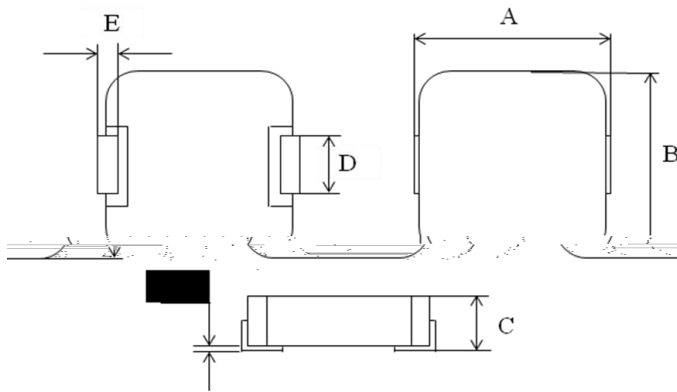

# TMAX-0630-XXX-M Molded Power Inductor

- 
- 
- 
- 
- 
- 

- 
- 
- 
- 
- 
- 
- 

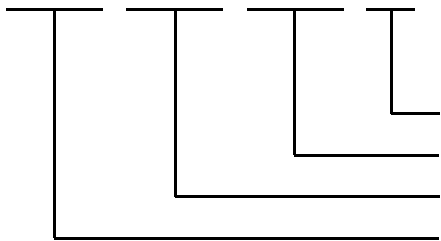

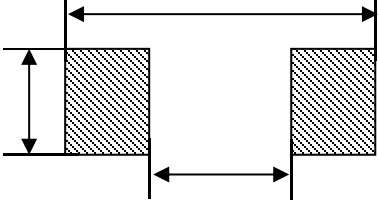

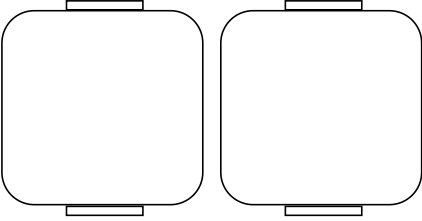

- 
- 

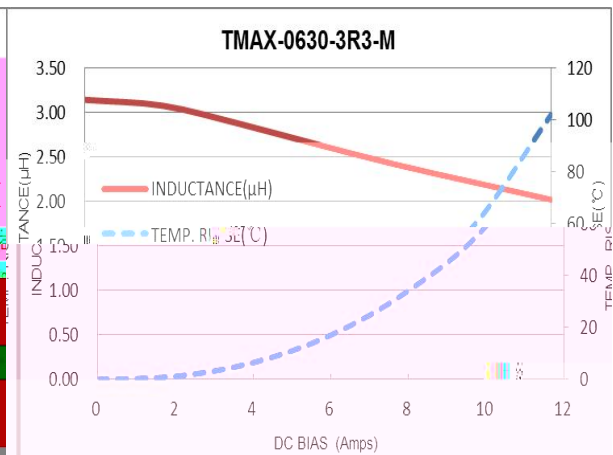
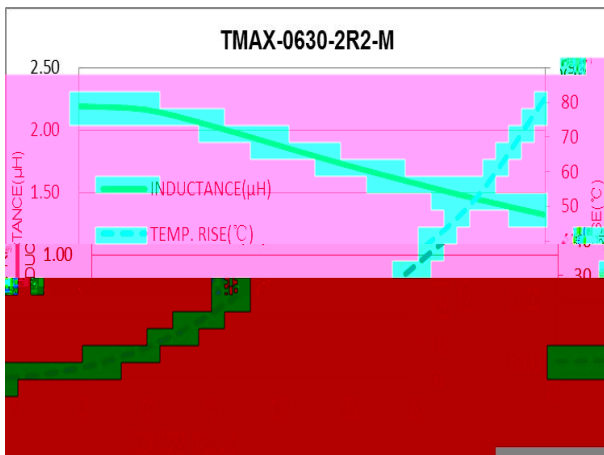
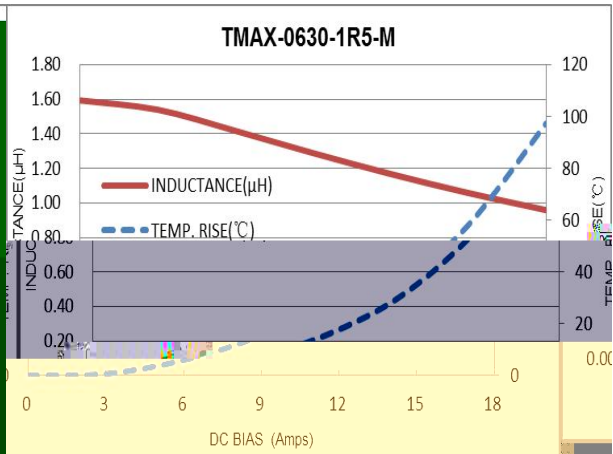
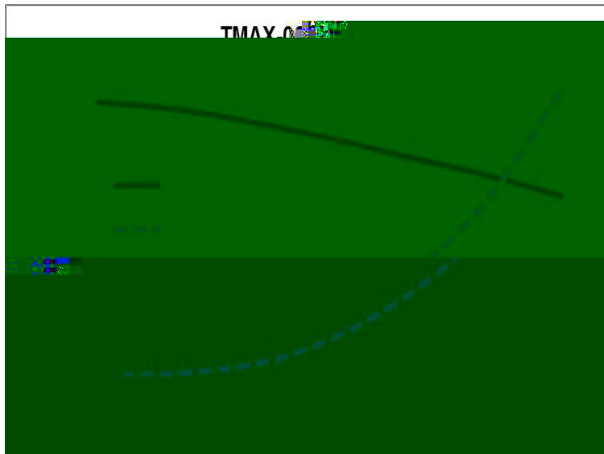
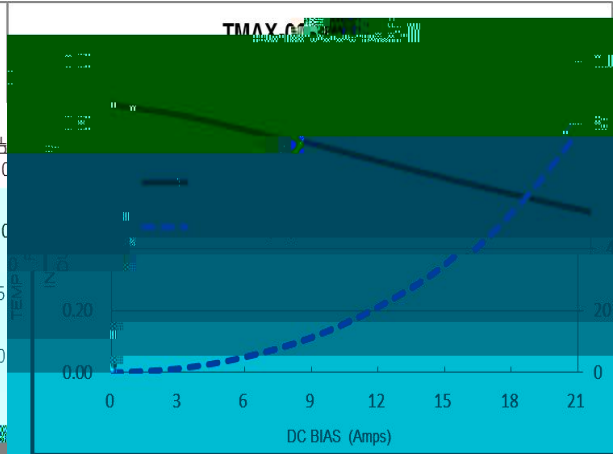
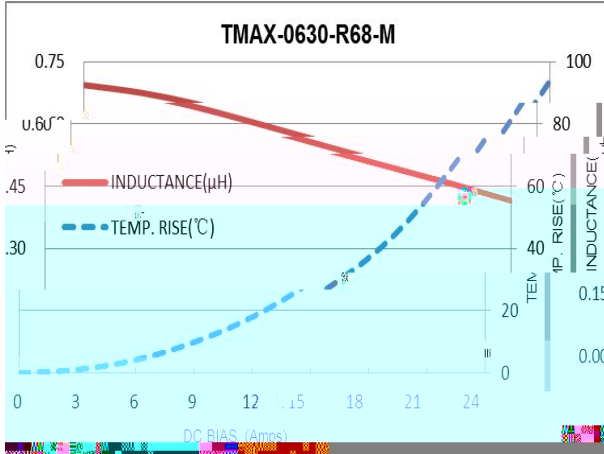

: ( ),  
( )

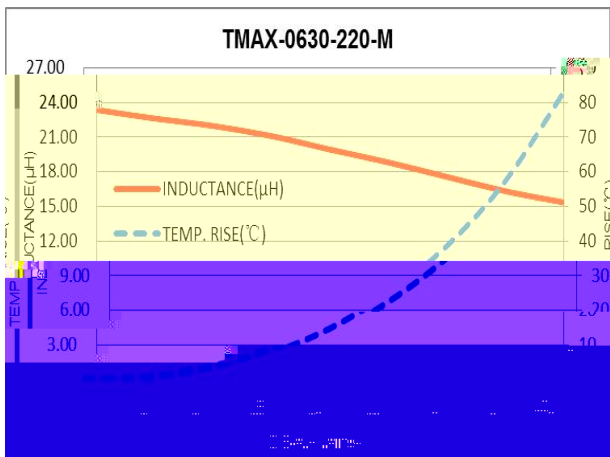
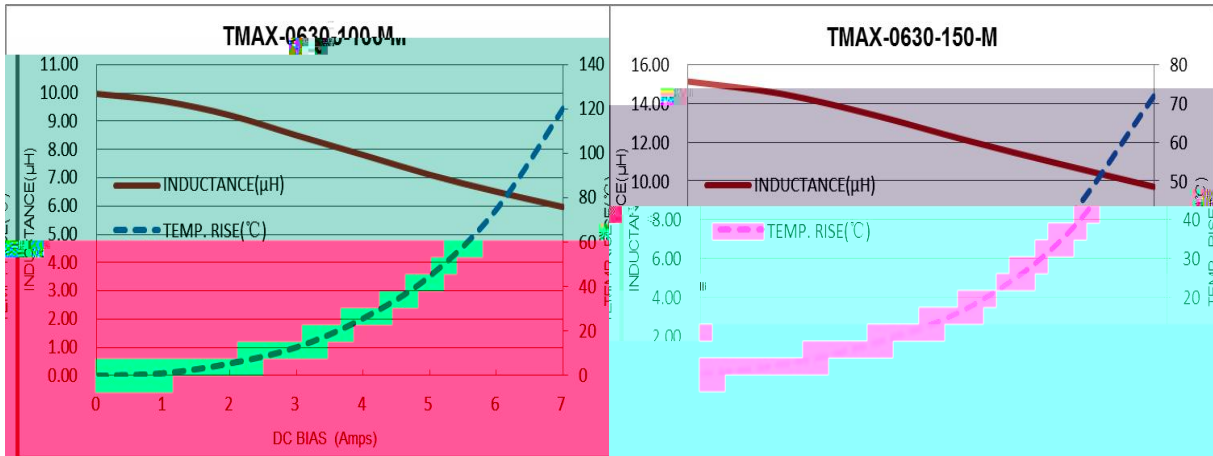
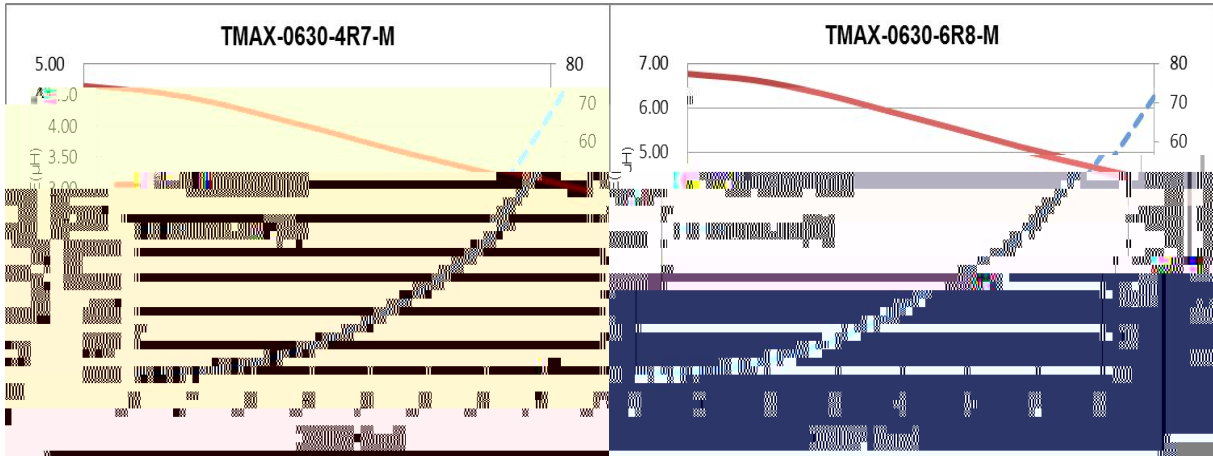





---

	$\pm$ $\pm$ $\rightarrow$ $\rightarrow$ $\pm$ $\pm$ $\rightarrow$	
		$\pm$
		$\pm$
		$\pm$
		$\pm$
		$\pm$



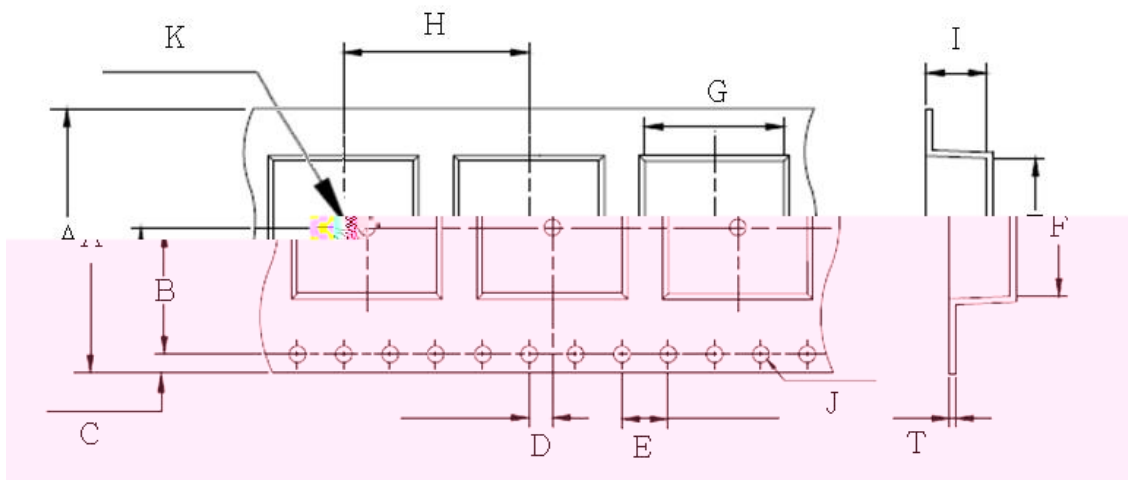

±	±	±	±	±	±
±	±	±	±	±	±

±	±	

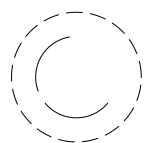

- 
- 

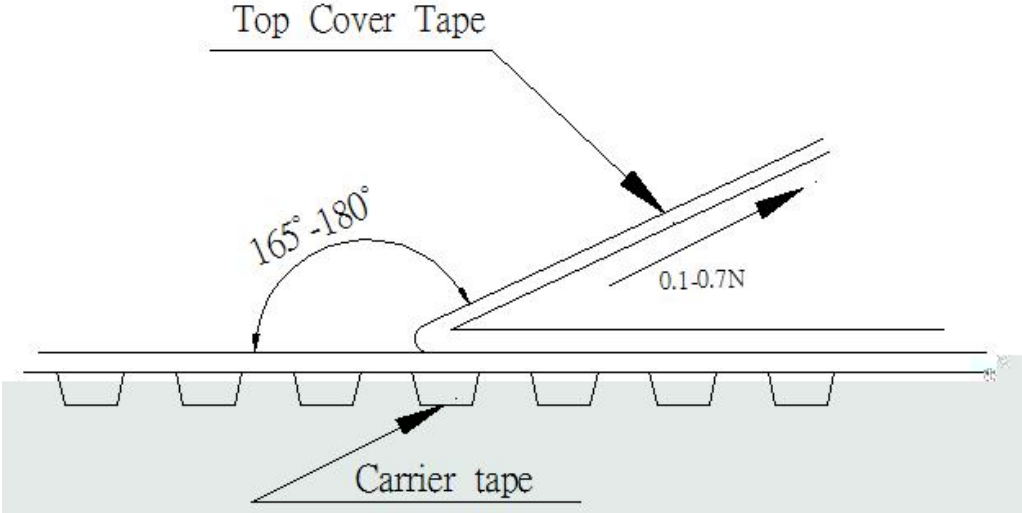

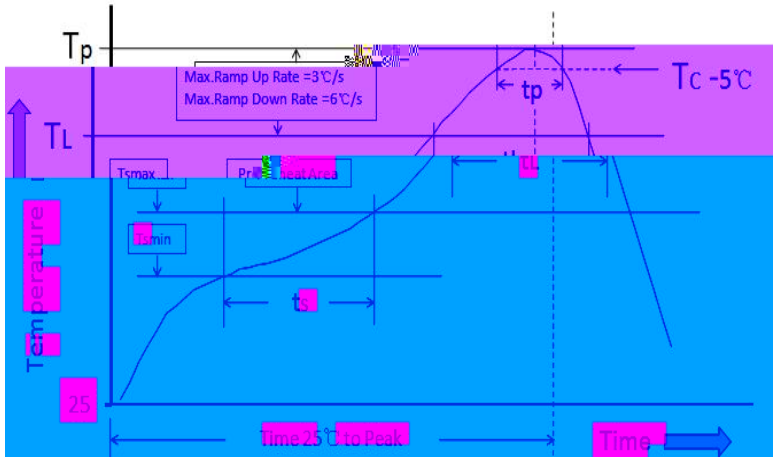

	<	≡
<	$^\circ\text{C}$	$^\circ\text{C}$
≡	$^\circ\text{C}$	$^\circ\text{C}$

	<		
<	$^\circ\text{C}$	$^\circ\text{C}$	$^\circ\text{C}$
	$^\circ\text{C}$	$^\circ\text{C}$	$^\circ\text{C}$
	$^\circ\text{C}$	$^\circ\text{C}$	$^\circ\text{C}$

	$^\circ\text{C}$	$^\circ\text{C}$
	$^\circ\text{C}$	$^\circ\text{C}$
	$^\circ\text{C}$	$^\circ\text{C}$
	$^\circ\text{C}$	$^\circ\text{C}$
$^\circ\text{C}$		
	$^\circ\text{C}$	$^\circ\text{C}$
$^\circ\text{C}$		

- 

-

